

MJTP SERIES 6MM & 4MM SMD TACT SWITCHES

FEATURES

- Numerous single pole-single throw momentary configurations.
- Excellent tactile feed-back (Snap dome).
- Ultra-compact size.
- Long operating life for high reliability.
- Molded-in terminals minimize wicking of flux or solder.

MATERIALS

Case: High temperature 4/6 nylon.
 Actuator: High temperature 4/6 nylon.
 Cover/Bracket: PET film, tin plated brass or stainless steel.
 Terminals: Silver plated brass.
 Shorting Contact: Phosphor bronze or stainless steel with silver plating.
 L.E.D. rating: Forward voltage- 2.1 V (3.0 V Max.). Cont. fwd. current 20mA max. @ 25°C.

Gold plating available on contacts & terminals
 - consult factory.

GENERAL SPECIFICATIONS

ELECTRICALS

Contact rating: 50 mA @ 12 VDC
 Insulation resistance: 100 megohms min. (100 VDC)
 Dielectric withstanding voltage: 250 VAC for 1 minute
 Contact resistance: 100 milliohms max. @ 5 VDC, 10 mA
 Electrical life: 100,000 cycles min. (1,000,000 cycles available - consult factory)
 Contact bounce: less than 10 msec.

MECHANICALS, THERMALS, ENVIRONMENTALS

Plunger travel: .010" + .008", - .004" (0,25 +0,2, -0,1 mm)
 Actuation force: 160 grams ±30 grams
 Operating temperature range: -20°C to +70°C
 Storage temperature range: -30°C to +80°C for 96 hours
 Shock resistance: 30G per method 213, MIL-STD-202
 Vibration resistance: passes method 201, MIL-STD-202

SOLDERING (note - non-washable except for models indicated as 'process compatible').

IR reflow soldering: 240°C max. for 20 seconds max.
 Wave soldering: 255°C max. for 5 seconds max.
 Hand soldering: 320°C max. for 3.5 seconds max. (40 watt iron max.)

SPECIFICATIONS SUBJECT TO CHANGE WITHOUT NOTICE.

US # MJTP1106S

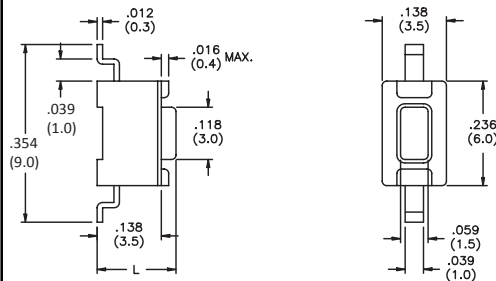

US Model No.	Dim. L (in./mm)
MJTP1106S	.169 (4,3)
MJTP1106SA	.197 (5,0)

Bulk packaged.

US # MJTP1106SATR

Same as above, except supplied on tape and reel as shown.

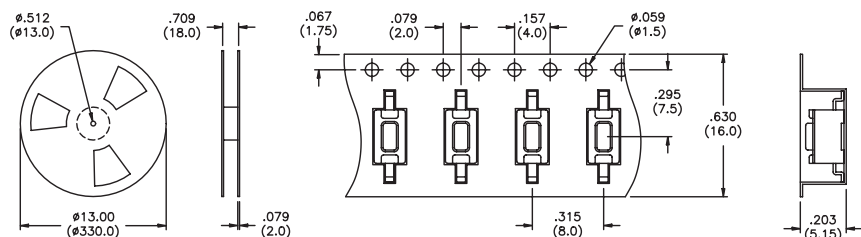

Tape & reel packaging - quantity 1800 per reel.

US # MJTP1122
Grounding

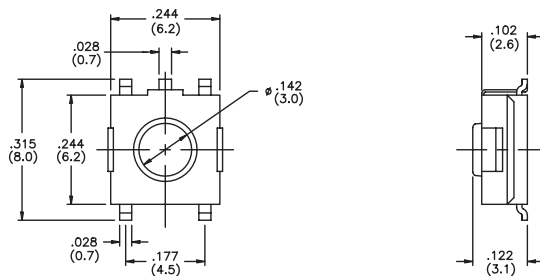

Bulk packaged.

US # MJTP1122A
Grounding

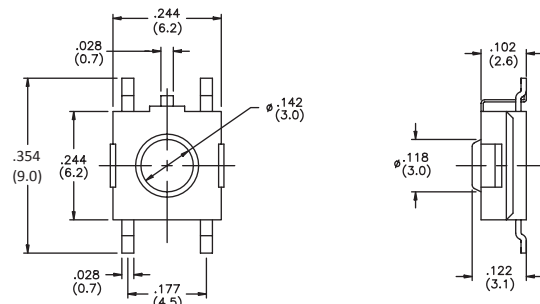

Bulk packaged.

US # MJTP1122B
EU # PHAP3374

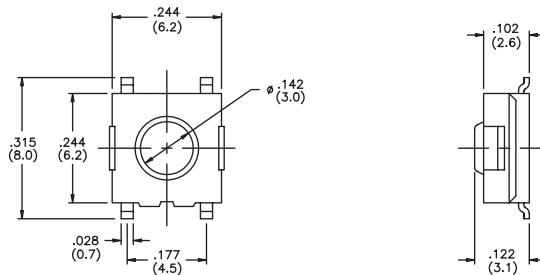

Bulk packaged.

US # MJTP1122TR,
MJTP1122BTR &
MJTP3374TR
EU # PHAP3374R

Same as above,
except supplied
on tape & reel
as shown.
Note -
MJTP1122A
not available on
tape & reel.

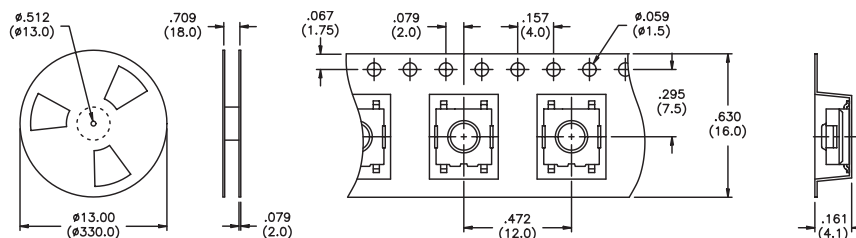

Tape & reel packaging - quantity 1500 per reel.

SPECIFICATIONS SUBJECT TO CHANGE WITHOUT NOTICE.

SPECIFICATIONS SUBJECT TO CHANGE WITHOUT NOTICE.

US # MJTP1125B

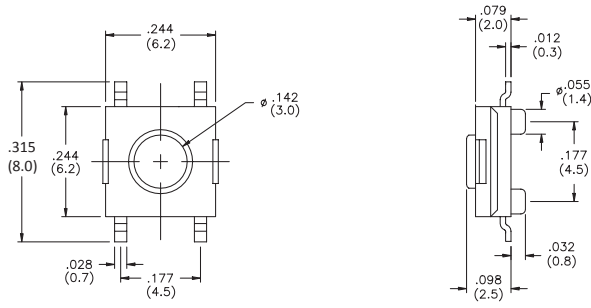

Bulk packaged.

**US # MJTP1138
EU # PHAP3368**

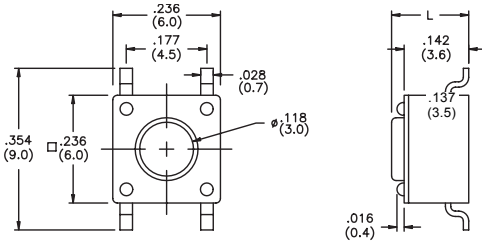

US Model No.	Dim. L (in./mm)	EU Model No.
MJTP1138	.170 (4,3)	PHAP3368
MJTP1138A	.197 (5,0)	PHAP3368A
MJTP1138B	.374 (9,5)	PHAP3368B
MJTP1138C	.315 (8,0)	PHAP3368C
MJTP1138D	.512 (13,0)	PHAP3368D
MJTP1138E	.287 (7,3)	PHAP3368E
MJTP1138F	.335 (8,5)	PHAP3368F
MJTP1138G	.275 (7,0)	N/A

Bulk packaged. Tubes available for some models consult factory.

US # MJTP1138TR

Same as above except supplied on tape & reel as shown.

Tape & reel:
 MJTP1138ATR = 500 pcs.
 MJTP1138BTR = 500 pcs
 MJTP1138CTR = 700 pcs
 MJTP1138ETR = 750 pcs
 MJTP1138FTR = 700 pcs
 MJTP1138GTR = 750 pcs

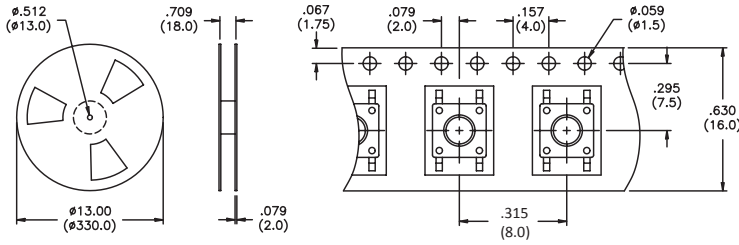

Part #	H
MJTP1138-	.213 (5.4)
MJTP1138A	.213 (5.4)
MJTP1138B	.394 (10.0)
MJTP1138C	.343 (8.7)
MJTP1138E	.299 (7.6)
MJTP1138F	.343 (8.7)
MJTP1138G	.299 (7.6)

MJTP1138TR & MJTP1138ATR: Tape & reel packaging - quantity 1200 pcs

US # MJTP1140
EU # PHAP3390
 4mm x 4mm

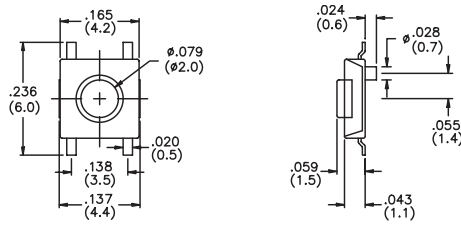

Bulk packaged.

US # MJTP1140A
EU # PHAP3391

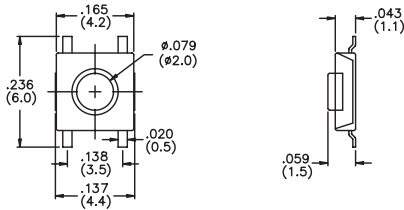

Bulk packaged.

US # MJTP1140TR & MJTP1140ATR
EU # PHAP3390R & PHAP3391R

Same as above, except supplied on tape & reel as shown.

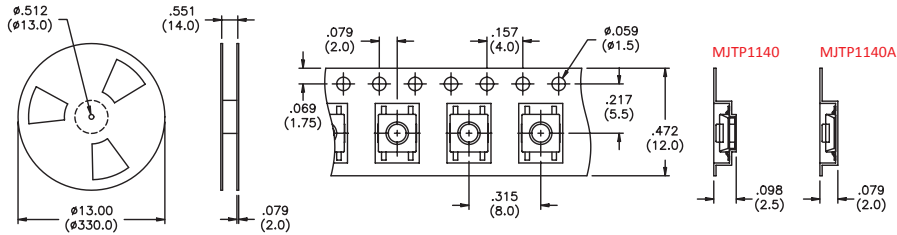

Tape & reel packaging - quantity 3400 per reel.

US # MJTP1162
EU # PHAP3371

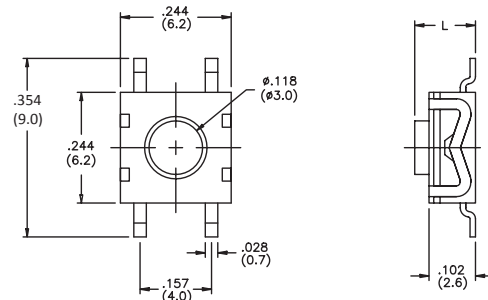

US Model No.	Dim. L (in./mm)	EU Model No.
MJTP1162	.102 (2,6)	PHAP3371
MJTP1162A	.134 (3,4)	PHAP3371A

Bulk packaged.

SPECIFICATIONS SUBJECT TO CHANGE WITHOUT NOTICE.

SPECIFICATIONS SUBJECT TO CHANGE WITHOUT NOTICE.

US # MJTP1162TR & MJTP1162ATR
EU # PHAP3371R & PHAP3371AR
 Same as above except supplied on tape & reel as shown.

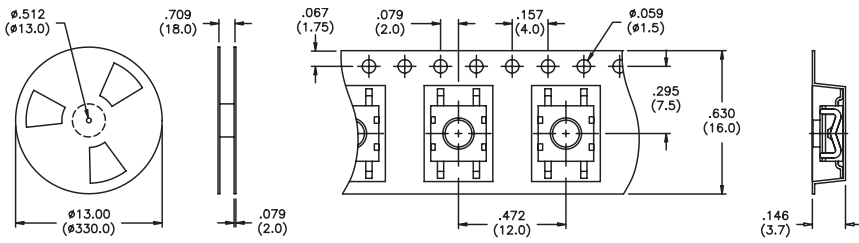

Tape & reel packaging - quantity 1600 per reel.

US # MJTPSJW66N
 Process compatible

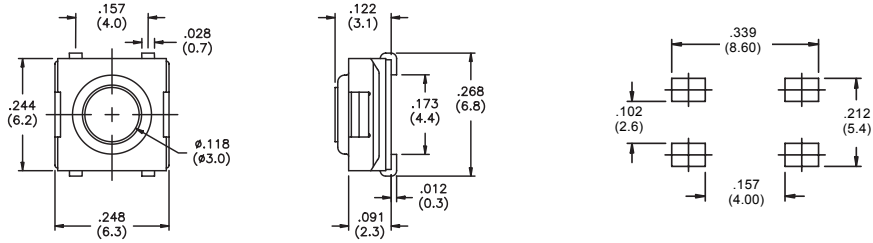

Bulk packaged.

US # MJTPSJW69N
 Process compatible

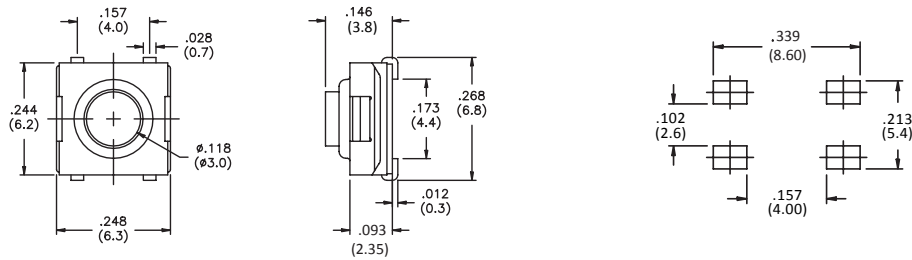

Bulk packaged.

US # MJTPSMW
 Process compatible

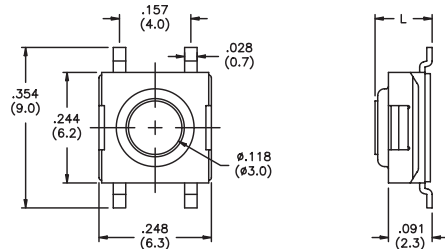

US Model No.	Dim. L (in./mm)
MJTPSMW	.122 (3,1)
MJTPSMWA	.091 (2,3)
MJTPSMWB	.146 (3,8)

Bulk packaged.

US # MJTPSMWTR & MJTPSMWATR, MJTPSMWBTR
 Same as above except supplied on tape & reel as shown.

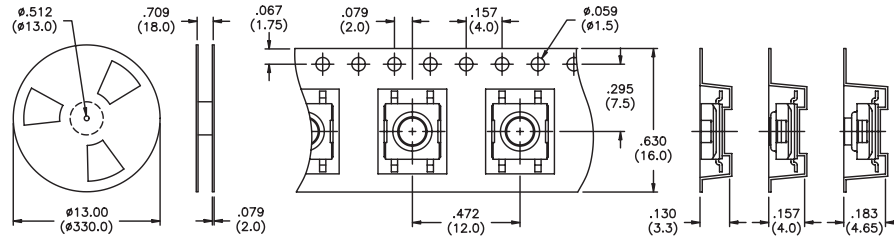

Tape & reel packaging - quantity 'MWTR' & 'MWATR' 2000 per reel, 'MWBTR' 1900 per reel.

SCHEMATICS

MJTP1122
 MJTP1125
 MJTP1137
 MJTP1138
 MJTP1140
 MJTP1162
 MJTPSJW66N
 MJTPSJW69N
 MJTPSMW

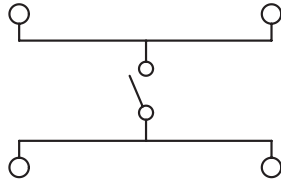

MJTP1106

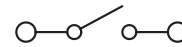

PRINTED CIRCUIT BOARD LAYOUTS

Layout tolerances; Linear: $\pm .004"$ ($\pm 0,1MM$) Holes: $\pm .002"$ ($\pm 0,05MM$) Pads: $\pm .008"$ ($\pm 0,2MM$)

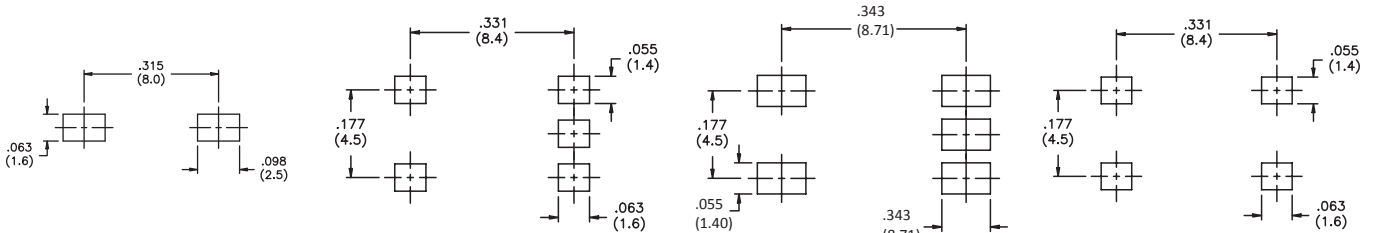

MJTP1106S

MJTP1122

MJTP1122A

MJTP1122B

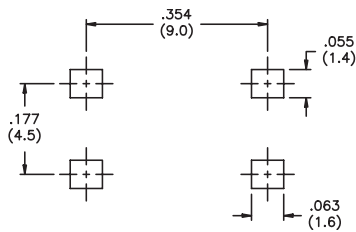

MJTP1138

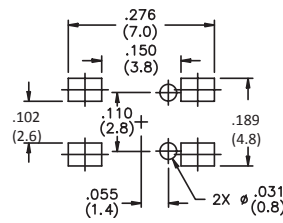

MJTP1140

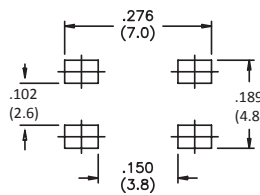

MJTP1140A

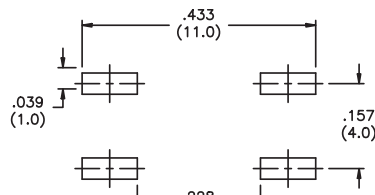

MJTP1162

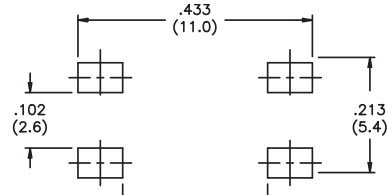

MJTPSMW

SPECIFICATIONS SUBJECT TO CHANGE WITHOUT NOTICE.

UC1506US